

# Zero point mounting *system 1000*

SPEEDY module plate, size 10 kN







Invest successfully and increase efficiency





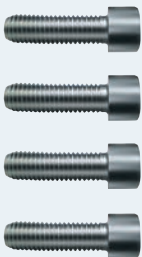

# Enhance the productivity of your company

## ■ SPEEDY module plates – for efficient setting-up

### Module plate start set, with overpressure release, order no. 803710

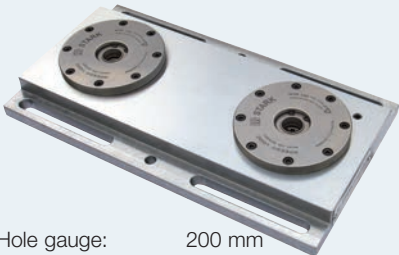
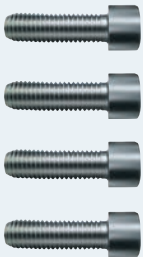
|   |   |   |   |   |
|---|---|---|---|---|
|                                  |  |  |  |  |
| Hole gauge: 200 mm<br>Insertion force: 2x 10'000 N<br>Operating pressure: 80 bar<br>Dimensions: 340 x 188 x 45 mm |   |   |   |   |
| Consisting of:  | <b>804 209</b>  | <b>931 059</b>  | <b>704 020</b>  | <b>803 411</b>  |
| Module plate double<br>SPEEDY 10 kN   | Retractable nipple<br>with zero point   | Cyl. head screw<br>M12x40   | Washer  | Footpump, system pressure 80 bar<br>air pressure max. 6 bar                         |

### Module plate extension set, order no. 803 711

|   |   |   |   |   |
|---|---|---|---|---|
|                                |  |  |  |  |
| Hole gauge: 200 mm<br>Insertion force: 2x 10'000 N<br>Operating pressure: 80 bar<br>Dimensions: 340 x 188 x 45 mm |   |   |   |   |
| Consisting of:  | <b>931 059</b>  | <b>704 020</b>  | <b>804 392</b>  | <b>P00036</b>   |
| Module plate double<br>SPEEDY 10 kN   | Cyl. head screw<br>M12x40   | Washer  | Swivel screw connector<br><b>804 369</b><br>Swivel screw connector                    | MS-Pipe Ø 4/6x80  |

### Module plate accessories

|   |   |   |   |   |   |
|---|---|---|---|---|---|
|  |  |  |  |  |  |
| <b>804 209</b>  | <b>804 230</b>  | <b>804 238</b>  | <b>804 259</b>  | <b>704 161</b>  | <b>804 255</b>  |
| Retractable nipple<br>with zero point   | Retractable nipple<br>with balancer   | Retractable nipple<br>without centering   | Positioning pin   | Slidingblock<br>with pin  | Torque wrench   |
|  |  |  |  |   | <b>804 257</b>  |
| <b>804 254</b>  | <b>804 368</b>  | <b>803 790</b>  | <b>803 791</b>  |   | Socket  |
| Retractable nipple key  | Coupling  | Rupture plug  | Nut for T-slot<br>M12x14  |   |   |

# The SPEEDY module plate keeps you flexible -always

## ■ SPEEDY module plate – Potential multiplier for your production

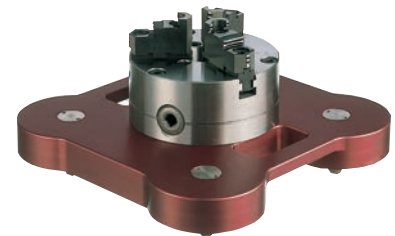
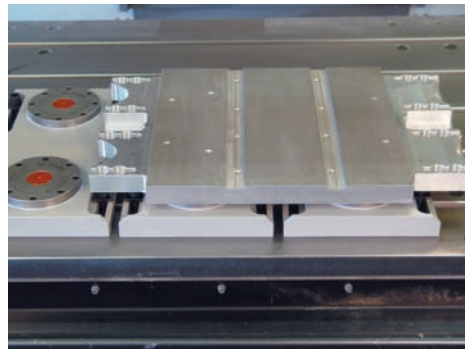
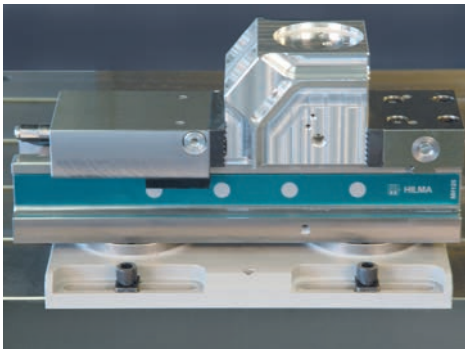
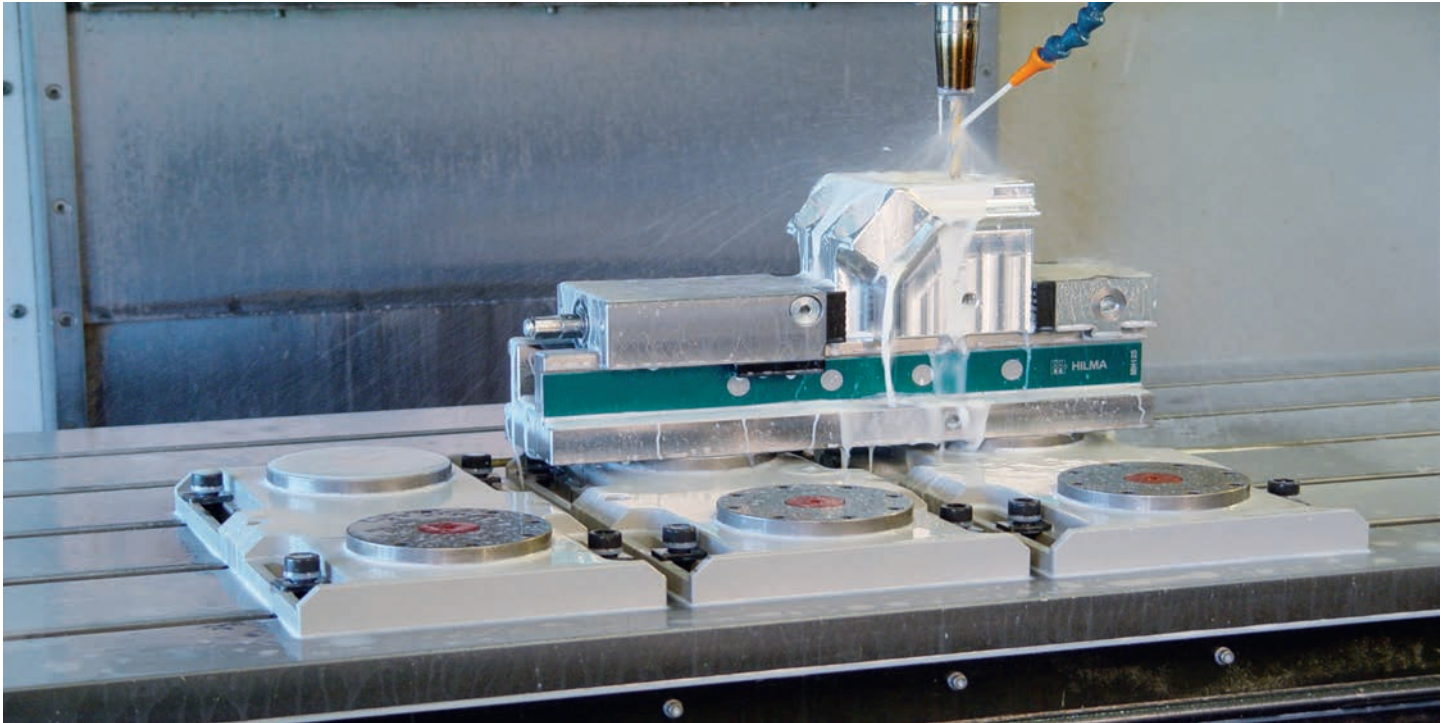

Jaw chuck palette (see main catalogue)

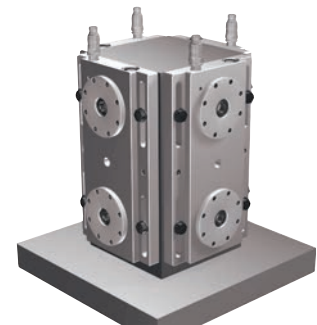

Module plate on mounting tower (versions on request)

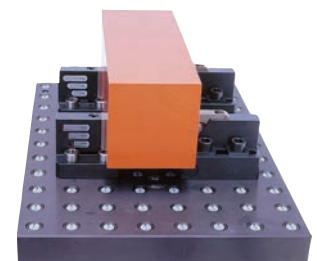

Perforated palette with down draw clamps (see main catalogue)

## Module plates - Examples for multiple applications

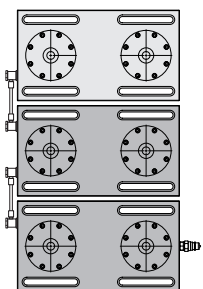

3 module plates

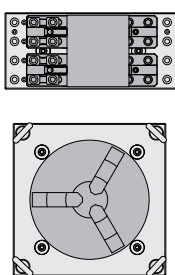

1 perforated palette with  
down draw clamps  
1 jaw chuck palette

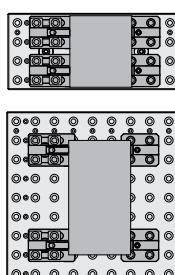

2 perforated pallet with  
down draw clamps

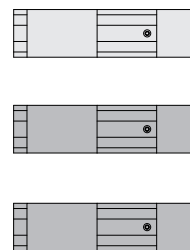

3 vises

Perforated palette with down draw clamps (see main catalogue)

## Setting-up the SPEEDY module plate – quick and easy

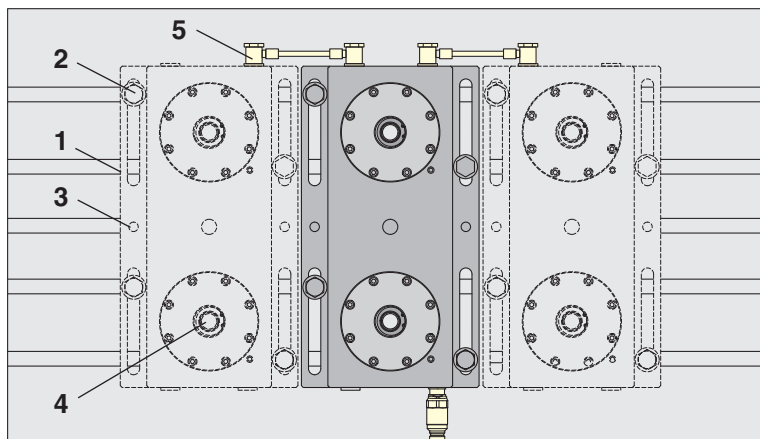

1. Align and screw on the SPEEDY module plate (1). Alignment also possible with the sliding block with pin (3) and positioning pin.
2. Move the positioning pin to the zero point (4).
3. With hole gauge (200mm), set the second and third module plates at the right or left.
4. Install the hydraulics (5).

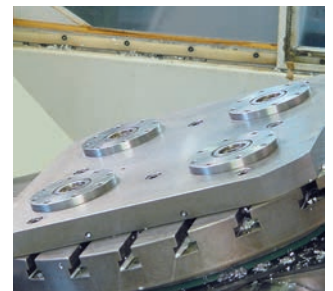
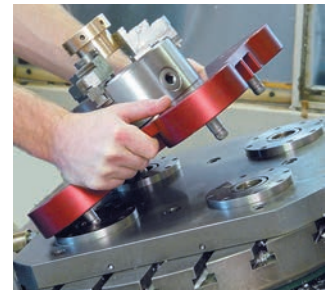

## SPEEDY module plates – a Stark innovation

- A low-cost entry into the clamping technology
- Flexible and module extensions
- Mountable on any machine table (machine independent)
- Significant savings in setting-up
- External setting-up extends machine production cycles



## The success multipliers - SPEEDY module plates guarantee increased efficiency in production

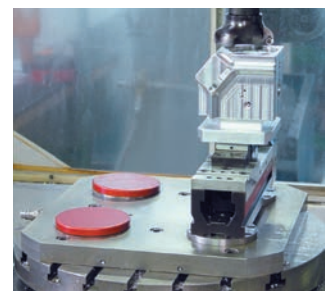

### Synergies of Core Competences

We are members of the ROEMHELD Group and our customers benefit from the synergies created by our cooperation with other competent technology companies. The ROEMHELD Group is globally oriented and serves industrial customers all around the world.



**ROEMHELD**  
HILMA • STARK

Intelligente Nullpunkt  
Spannsysteme



**ROEMHELD**  
HILMA • STARK

Spanntechnik  
Montage- und  
Handhabungstechnik  
Lineartechnik  
Industrieaggregate



**ROEMHELD**  
HILMA • STARK

Flexible Spannsysteme  
Maschinenschraubstücke  
Werkzeug-Spanntechnik  
Magnet-Spanntechnik



**FRIEDRICHSHÜTTE**

Grauguss und Sphäroguss  
komplex und bearbeitet

Stark Spannsysteme GmbH  
Kommingerstrasse 48  
A-6840 Götzis  
Tel.: ++43 (0)5523 64 739-0  
Fax: ++43 (0)5523 64 739-7  
E-Mail: [verkauf@stark-inc.com](mailto:verkauf@stark-inc.com)  
[www.stark-inc.com](http://www.stark-inc.com)